

Minimum Requirements

- Broadband Internet Service (Cable or DSL Modem)
- Internet Browser (Internet Explorer, Safari, Firefox, Chrome)
- EnGenius Wireless Management L2 Switch (To use with EWS Series Management Switches)

Quick Installation Guide

EWS Series Access Point
version 1.0

Wireless Managed Indoor Access Point

1 Connecting the Access Point (Through EnGenius Wireless Management Switch)

- Connect one end of the **Ethernet Cable** into an **Ethernet Port** on the front panel of the EnGenius Wireless Management Switch and the other end to the Ethernet Port on the computer.
- Connect another **Ethernet Cable** into the **LAN Port** of the Managed AP and the other end to the **Ethernet Port** on the Wireless Management Switch. With the Wireless Management Switches, the Managed AP is able to obtain proper assigned IP address for further configurations.

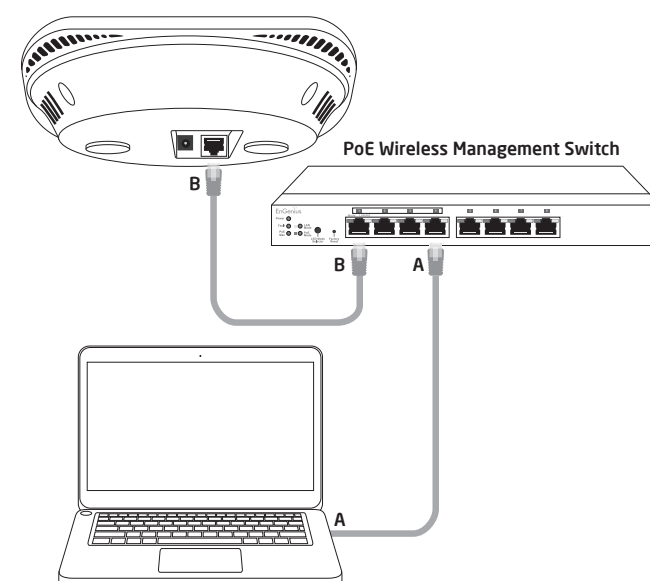

2 IP Address Configuration

- Once your computer is on, ensure that your TCP/IP is set to **On** or **Enabled**. Open Network Connections and then click **Local Area Connection**. Select **Internet Protocol Version 4 (TCP/IPv4)**.

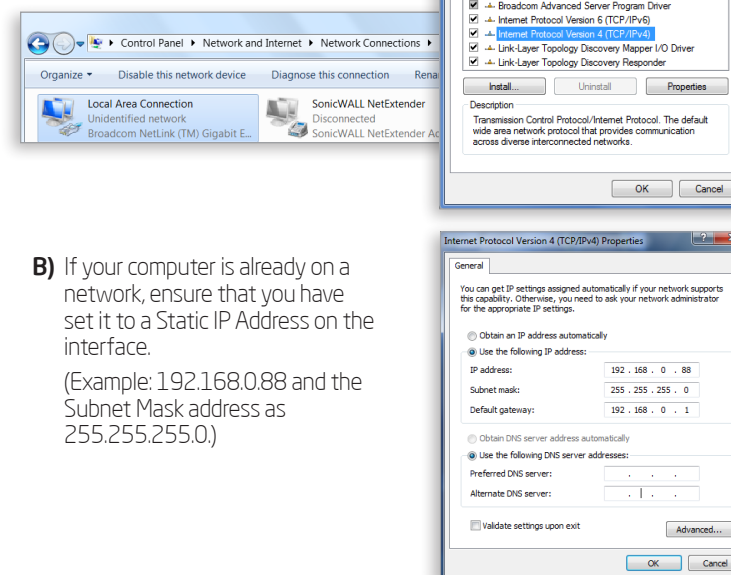

- If your computer is already on a network, ensure that you have set it to a Static IP Address on the interface.
(Example: 192.168.0.88 and the Subnet Mask address as 255.255.255.0.)

3 Management Switch Setup

- Open a web browser on your computer. In the address bar of the web browser, enter **192.168.0.239** and **enter**.
- A login screen will appear. By default, username is **admin** and the password is **password**. Enter the current username and password of the Wireless Management Switch and then click **Login**.

* Your model number may be different in the web browser interface.

- The EnGenius Wireless Management Switch User Interface will appear. Make sure the **Controller State** is set to **Enabled**.

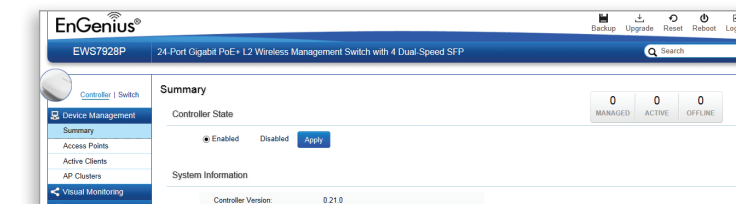

4 Adding Managed AP (Through EnGenius Wireless Management Switch GUI)

- All Managed AP(s) connected to the same network as the Wireless Management Switch will appear on the right side of the screen, under the Access Point **AP(s) Detected** list. Locate and select the Managed AP by checking the box and click **Add** to manage the device.

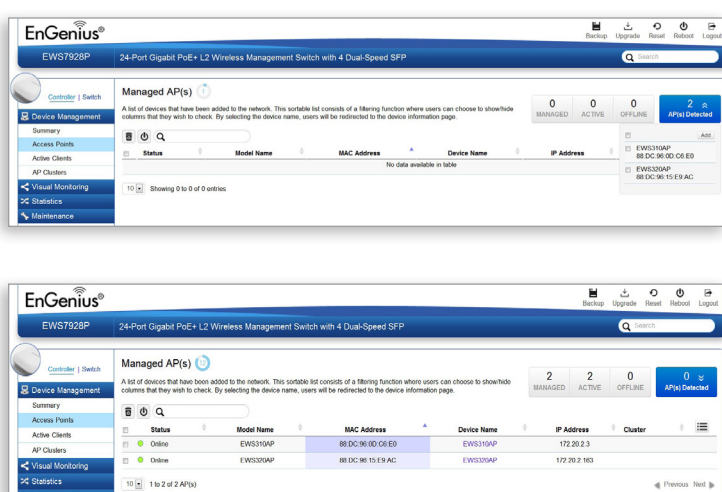

- You may configure your Managed AP(s) after you successfully connected to the Wireless Management Switch through its **GUI**.

5 Configuring Managed AP (Through EnGenius Wireless Management Switch GUI)

- Configure Managed AP(s) through the GUI interface from the switch for WLAN settings under **Device Management**. Click the "Device Name" in order to configure your Managed AP.

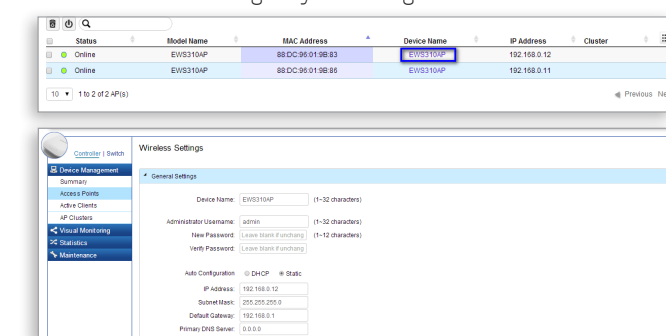

- Add Managed AP(s) to specific **AP Cluster** to save repetitive configuration tasks.

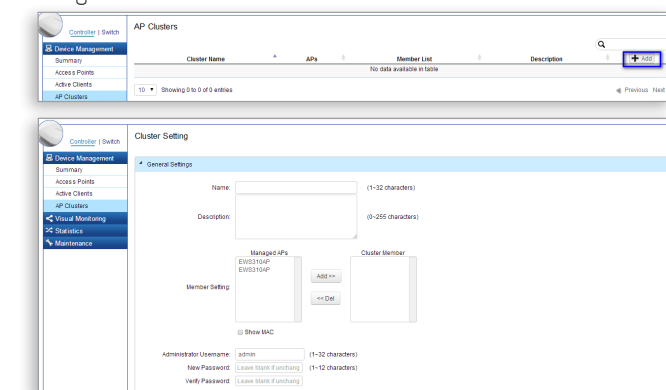

- Users may create several clusters simultaneously to accommodate their deployments under **AP Clusters**.

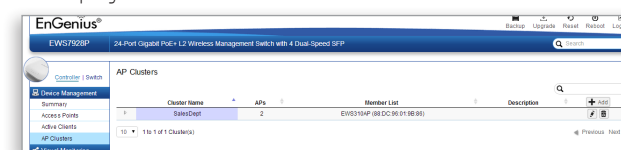

- For distinct settings, EnGenius Wireless Management switches still offer individual Managed Access Point customization for cluster members such as different channels that best adapt your local WLAN deployments.

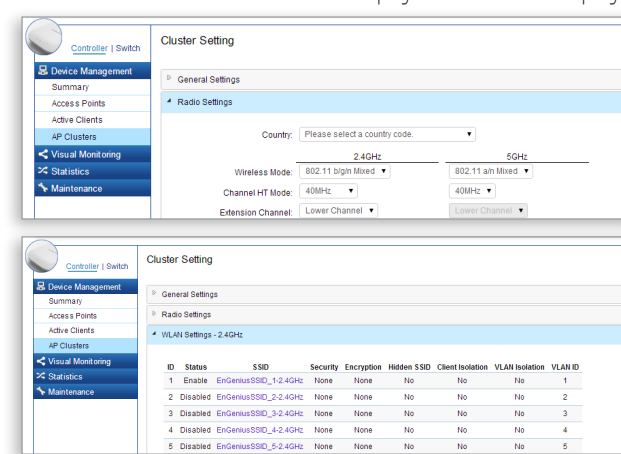

- Upon successful connection and setup, user can go through different sections on the web management pages to unleash Managed AP's full features for your WLAN deployment and performance monitoring.

Mounting the Access Point

The AP can be ceiling mounted or wall mounted depending on the setup.

To attach the AP to a ceiling or wall using the mounting bracket:

- Attach the mounting bracket to the wall or ceiling using the provided mounting kit.
- Insert the provided short screws into the mounting holes. Make sure there's enough space between the screws and unit for the mounting bracket. If extra space is required, use the provided spacers and long screws from the T-Rail mounting kit.
- Mount the AP to the mounting bracket by rotating the unit clockwise about 90 degrees to secure it in place.

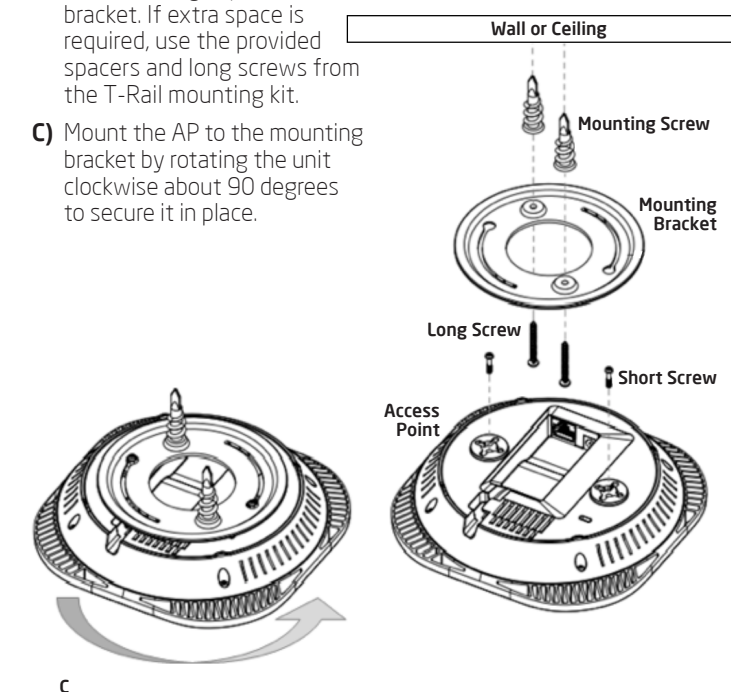

To attach the AP to a ceiling using T-Rail connectors:

- Attach the T-rail connectors to the bottom cover of the AP using the provided short screws. Use appropriate size T-rail connectors (1.5/16" or 9/16"). If extra space is required to accommodate drop ceiling tiles, use the provided spacers and long screws.

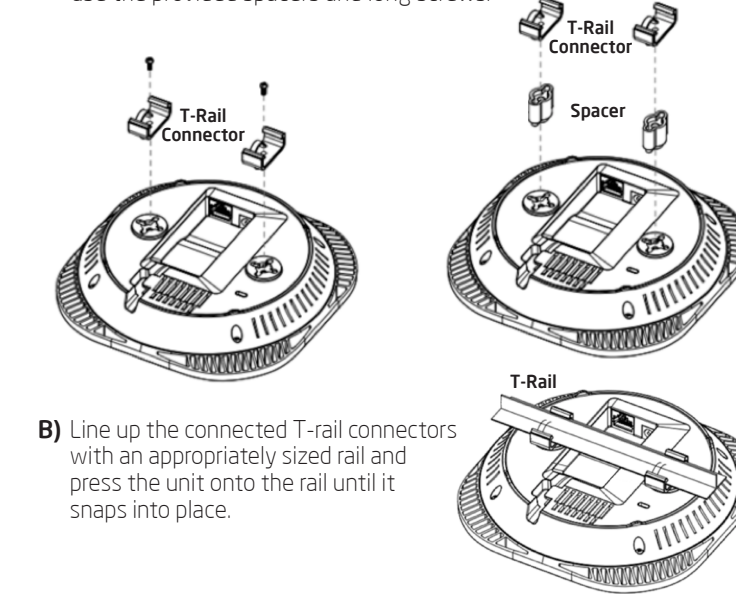

- Line up the connected T-rail connectors with an appropriately sized rail and press the unit onto the rail until it snaps into place.

Note: To protect your Access Point, use the Kensington security slot to attach a cable lock (cable lock is not included).

Stand-alone Access Point Installation

1 Connecting the Access Point

- Connect one end of the **Ethernet cable** into the **LAN port** of the Access Point and the other end to the **Ethernet port** on the computer.
- Connect the **Power Adapter** to the **DC-IN port** of the Access Point and plug the other end into an electrical outlet.

Note: The Access Point supports both **IEEE 802.3at PoE** (Power over Ethernet) or the included power adapter. You may use either one as the power source. **DO NOT use both at the same time.**

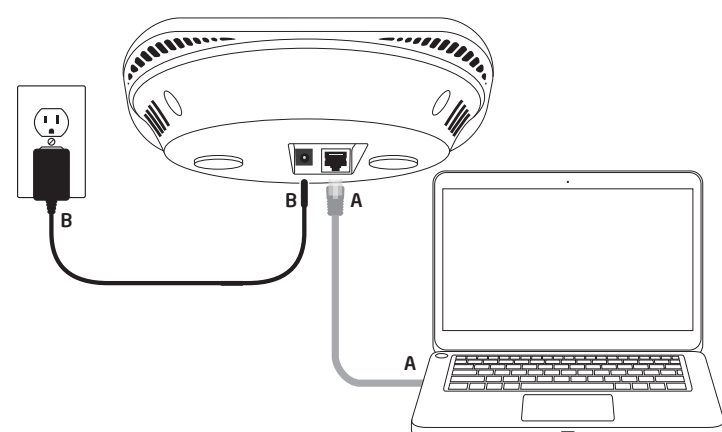

2 IP Address Configuration

- Once your computer is on, ensure that your TCP/IP is set to **On** or **Enabled**. Open Network Connections and then click **Local Area Connection**. Select **Internet Protocol Version 4 (TCP/IPv4)**.

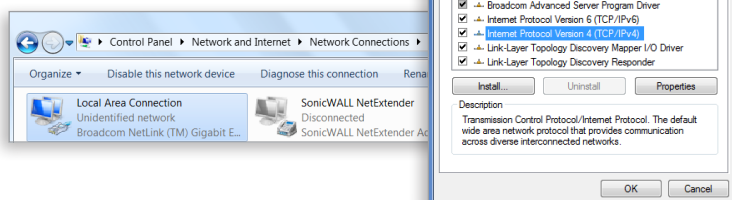

- If your computer is already on a network, ensure that you have set it to a Static IP Address on the interface.
(Example: 192.168.1.10 and the Subnet Mask address as 255.255.255.0.)

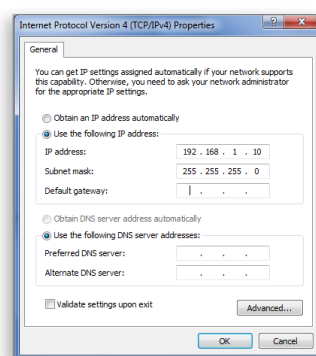

3 Access Point Setup

- Open a web browser on your computer. In the address bar of the web browser, enter **192.168.1.1** and **enter**.

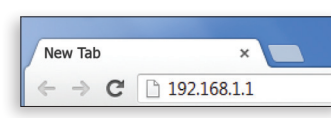

- A login screen will appear. By default, the username of the Access Point is **admin** and the password is **admin**. Enter the current username and password of the Access Point and then click **Login**.



- The EnGenius Access Point User Interface will appear. This device can operate in Access Point operating mode.

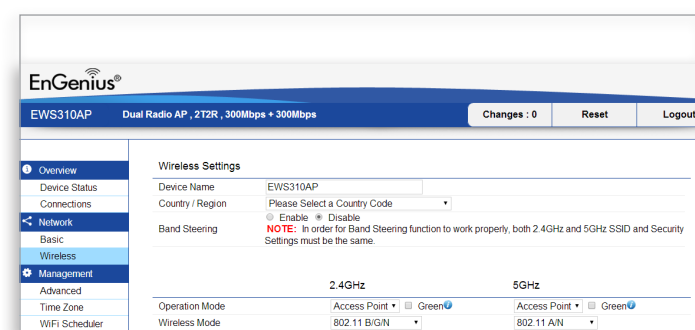

* Your model number may be different in the web browser interface.

Technical Support

Country of Purchase	Service Center	Service Information
North America www.engeniustech.com	Canada	rma@engeniustech.com Toll Free: (+1) 888 397 2788 Local: (+1) 905 940 8181
www.engeniustech.com	Los Angeles, USA	support@engeniustech.com Toll Free: (+1) 888 735 7888 Local: (+1) 714 432 8658
Central & South America es.engeniustech.com pg.engeniustech.com	Miami, USA	miamisupport@engeniustech.com Miami: (+1) 305 887 7378 Sao Paulo, Brazil: (+55) 11 3957 0303 D.F. Mexico: (+52) 55 1163 8894
Europe www.engeniustech.com	Netherlands	support@engeniustech.com (+31) 40 8200 887
Africa CIS Middle East Russia www.engeniustech.com	Dubai, UAE	support@engeniustech.com Toll Free: 800-EnGenius 800-364-364-87 General: (+971) 4 357 5599
Asia Oceania www.engeniustech.com.sg	Singapore	www.engeniustech.com.sg/e_warranty_form techsupport@engeniustech.com.sg Toll Free: Singapore: 1800 364 3648
Others www.engeniustech.com	Taiwan, R.O.C	technology@senao.com

Notes

Maximum data rates are based on draft IEEE 802.11ac and IEEE 802.11 standards. Actual throughput and range may vary depending on many factors including environmental conditions, distance between devices, radio interference in the operating environment, and mix of devices in the network. Features and specifications subject to change without notice. This device complies with Part 15 of the FCC Rules. Operation is subject to the following two conditions: (1) this device may not cause harmful interference, and (2) this device must accept any interference received, including interference that may cause undesired operation. Trademarks and registered trademarks are the property of their respective owners. For United States of America: Copyright ©2014 EnGenius Technologies, Inc. All rights reserved.